



BRITISH COLUMBIA BUILDING CODE ENGINEERING EVALUATION REPORT

Date | 2022-12-31
Report No. | 0084-3-3-5875
For | Trex Company, Inc.
Address | 160 Exeter Dr., Winchester, VA 22603-8605

Subject

Trex Enhance® Basics and Naturals Wood-Plastic Composite Deck Boards

Evaluation Scope

This report is provided to assist registered design professionals and building officials in Canada with determining compliance to the performance objectives in the named building codes.

The material(s) and system(s) described herein have been evaluated to the 2018 British Columbia Building Code (BCBC), Division A, Sections 1.2.1.1.(1)(a) and 1.2.1.1.(1)(b) for compliance with the objectives and functional statements attributed to the applicable acceptable solutions in Division B, for buildings classified under Part 3/4/5 and Part 9 construction.

CSI DIVISION: 06 00 00 WOOD, PLASTICS, AND COMPOSITES
SUBDIVISION: 06 53 00 Plastic Decking

CODE SECTIONS AND STANDARDS:

| BCBC Div. B Section | Description | Referenced Standard or Div. B Section ¹ | Year |
|----------------------|--|--|------|
| 3.1.12.1.(2) | Determination of (Flame-Spread and Smoke Developed Classification) Ratings | CAN/ULC-S102.2 | 2018 |
| 3.4.6.1 | Slip Resistance of Ramps and Stairs | - | - |
| 3.8.3.2.(2)(c) | Accessible Path of Travel | 3.8.3.6 | - |
| 3.8.3.3.(1)(a) | Exterior Walks | - | - |
| 4.1.3.2 | Strength and Stability | Table 4.1.3.2.-A | - |
| 4.1.3.4 | Serviceability | 4.1.3.5 | - |
| 4.1.3.5.(1)(a) | Deflection | - | - |
| 4.1.4.1.(1) | Dead Loads | - | - |
| 4.1.5 | Live Loads Due to Use and Occupancy | Table 4.1.5.3 | - |
| 4.1.6 | Loads Due to Snow and Rain | - | - |
| 4.1.7.1.(5)(a) | Wind Load | 4.1.7.3 | - |
| 4.3.1.1 ² | Design Basis for Wood | CSA O86 | 2014 |
| 4.3.1.3 ² | Termites | 9.3.2.9 | - |



| BCBC Div. B Section | Description | Referenced Standard or Div. B Section ¹ | Year |
|--------------------------------|---|--|------|
| 9.3.2.2 ² | Lumber Grades | Table 9.3.2.1 | - |
| 9.3.2.9.(5)(c)(i) ² | Termite and Decay Protection | CAN/CSA-O80.1 | 2008 |
| 9.4.1.1.(1)(c)(i) | Structural Design Requirements and Application Limits | Part 4 | - |
| 9.4.2 | Specified Loads | - | - |
| 9.4.2.3 | Platforms Subject to Snow and Occupancy Loads | - | - |
| 9.4.3.1 | Deflections | Table 9.4.3.1 | - |
| 9.5.2.1.(1) | Barrier-Free Design, General | 3.8 | - |
| 9.8.9.1 | Loads on Stairs and Ramps | - | - |
| 9.8.9.6.(2) | Finish for Treads and Landings | - | - |
| 9.10.3.2 | Flame Spread Ratings | Part 3, App. D | - |
| 9.23.3.1.(3) | Standards for Nails and Screws | ASME B18.6.1 | 1981 |
| 9.30.3.1.(1) ² | Wood Strip Flooring, Thickness | Table 9.30.3.1 | - |

1. Only the applicable reference standards and code sections cited in the main body text are listed. (-) indicates that the main body text covers the full explanation of the objective.
2. Alternative solution evaluation completed for these code sections. See Attachment 3 for discussion of methodology.

COMPLIANCE STATEMENT:

It is the opinion of Boca Engineering Co. that Trex Enhance® Basics and Naturals Wood-Plastic Composite Deck Boards, when installed as described in this report, have demonstrated compliance with the objectives and functional statements of the listed sections of the 2018 British Columbia Building Code. Design and performance information can be found in the Product Evaluation section of this report.

This report has been prepared and reviewed on behalf of Boca Engineering Co. by:

Christopher Bowness, P.Eng., P.E.

2022-12-31

Date

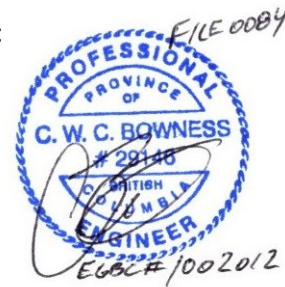

PRODUCT EVALUATION _____ Pg. 3 - 8

ATTACHMENTS:

1. Materials Properties as per ASTM D7032 _____ Pg. 9
2. Deck Board Profile and Installation Diagrams _____ Pg. 10-11
3. Discussion of Limit States Design Procedure _____ Pg. 12-13

EVALUATION REPORT TERMS:

1. This report is a general evaluation of the building code section requirements as identified and applies only to the samples that were evaluated. It does not imply any endorsement or warranty, nor that the signatory Engineer is the Designer of Record of any construction project for which the information is used.
2. This Evaluation Report expires Dec. 31, 2023, open to renewal. Up to the renewal date, the report is valid until such time as the named product(s) changes, the Quality Assurance Agency changes, or provisions of the Code that relate to the product change.



Product Evaluation

1.0 PRODUCT DESCRIPTION:

Trex Enhance® Basics and Naturals deck boards are composed of a recycled low-density polyethylene (LDPE) and wood fiber composite. The plank profile is nominal 1 inch by 5.5 inch (25 mm x 140 mm), in lengths of 12, 16 and 20 ft (3.7, 4.9, and 6.1 m), weighing 1.9 lb/ft length (2.8 kg/m), with top surface finish of an embossed simulated wood-grain pattern. The bottom surface is fluted, and side edges are either flat or grooved to fit hidden fasteners.

Deck boards are supplied in a variety of colours, and are intended for use as a walking surface on exterior decks, balconies, porches, and walkways, including stairs.

1.1 MATERIAL PROPERTIES:

The materials properties of Trex Enhance® Basics and Naturals deck boards, tested as per ASTM D7032, *Standard Specification for Establishing Performance Ratings for Wood-Plastic Composite and Plastic Lumber Deck Boards, Stair Treads, Guards, and Handrails*, are provided in Attachment 1, Table 1 of this report.

2.0 INSTALLATION:

1. Manufacturer's published installation instructions are available online at: <https://www.trex.com/trex-owners/customer-support/downloads/#productinstall>.
2. Manufacturer's installation instructions, building code, and additional details in this report are to be followed.

3.0 CODE SECTIONS REVIEW:

| <u>BCBC Div. B Section</u> | <u>Description</u> |
|--------------------------------|--------------------|
|--------------------------------|--------------------|

| | |
|---------------------|---|
| 3.1.12.1.(2) | Determination of (Flame-Spread and Smoke Developed Classification) Ratings |
|---------------------|---|

Trex Enhance® Basics and Naturals deck boards have been tested to CAN/ULC S102.2 and received a flame-spread rating of 45.

Comparable use materials in BCBC App D Tables D-3.1.1.-A & B, with an assigned flame-spread rating:

Lumber: 150; Hardwood or Softwood Flooring: 300

Flame-spread rating of 45 is equal to or better than that of the comparable materials.

Deck boards are for exterior use only, therefore the smoke developed index is regarded as not applicable.

| | |
|----------------|--|
| 3.4.6.1 | Slip Resistance of Ramps and Stairs |
|----------------|--|

Trex Enhance® Basics and Naturals deck boards, for use as surfaces for ramps and stairs, have been tested to ASTM F1679, *Standard Test Method for Using a Variable Incidence Tribometer (VIT)*, and received coefficient of friction values of:



| Enhance G2 Deck Boards ASTM F1679 Coefficient of Friction | |
|--|------|
| Parallel (Dry): | 0.51 |
| Parallel (Wet): | 0.34 |
| Perpendicular (Dry): | 0.53 |
| Perpendicular (Wet): | 0.38 |

This Code section requires that the surfaces of ramps, and landings and stair treads shall have a finish that is “slip resistant.” The term slip resistant is called for in several places throughout the Code but is never quantified to how “slip resistant” is defined or measured.

The common industry practice is to test materials to a nationally recognized standard and report the coefficient of friction between the walking surface and a rubber material representing the sole of footwear.

International standard ASTM D7032 calls for Slip Resistance testing conducted to ASTM F1679.

The determination of code compliance is discretionary to the building design requirements, which reverts to the discretion of the design professional and/or the AHJ.

Guidance on designing for slip resistance can be found in CSA B651, referenced in BCBC 3.8.3.1.(1).

3.8.3.2.(2)(c) Accessible Path of Travel

Calls for exterior walking surfaces within barrier-free path of travel to be “stable, firm and slip-resistant.” Trex Enhance® Basics and Naturals deck boards installed under specified loads as described in this report meet the deflection limits of BCBC 4.1.3.5.(1)(a), and slip resistance has been quantified in commentary to BCBC 3.4.6.1, to satisfy the requirements of this Code section.

3.8.3.3.(1)(a) Exterior Walks

Requires that exterior walks have a “slip-resistant, continuous and even surface.” See this report commentary to BCBC 3.4.6.1 and 3.8.3.2.(2)(c).

4.1.3.2 Strength and Stability

Design service live load capacity of the deck boards is maximum 100 psf (4.8 kPa) @ 16-inch (450-mm) o/c supports.^{1, 2, 3}

Design non-factored wind uplift pressure capacity of the deck boards is maximum 125 psf (6.0 kPa) @ 16-inch (450-mm) o/c supports.

| Span (in, mm) | Enhance G2 Deck Boards Maximum Live Load (psf, kPa) | | |
|------------------|--|--------------------|-------------------|
| | Deflection Limit | | |
| | L/180 | L/240 | L/360 |
| 16 in 405 mm | 100 psf 4.8 kPa | 100 psf 4.8 kPa | 71 psf 3.4 kPa |

1. Calculated using the published strength and stiffness values in Table 1 of this report, deck board spanning and secured to a minimum of three supports, applying an L/240 live load deflection limit, and a total dead load of 0.5 kPa. See table for other load and deflection limit values.

2. Other loading conditions limits may be calculated using the materials values published in Table 1 of this report.

3. Deck boards tested in manner intended for use were subjected to maximum compression and shear forces for loading condition, where bending strength and deflection were shown to be the governing limit states.



The load combinations in BCBC Table 4.1.3.2.-A that are applicable to the use of this product are those with Dead, Live, Wind, and Snow.

The allowable strength capacity of Trex Enhance® Basics and Naturals deck boards is published as the tested ultimate strength values adjusted for reductions due to temperature and moisture effects, with a safety factor of 2.5. The 2.5 factor may be regarded as the limit states load factor divided by the resistance factor.

4.1.3.4 Serviceability

Serviceability considerations of deflection under load, long-term durability and creep have been evaluated through testing, as reported in Attachment 1, Table 1 of this report.

4.1.3.5.(1)(a) Deflection

The deflection limit of L/180 (0.09-inch [2.2 mm] @ 16-inch span) @ 100 psf (4.8 kPa) live load is in conformance with CSA 086 clause 5.4.2.

4.1.4.1.(1) Dead Loads

Dead load of Trex Enhance® Basics and Naturals deck board material weight and accessories may be taken as 4.2 psf (0.2 kPa).

4.1.5 Live Loads Due to Use and Occupancy

Live loads for occupancy use are found in BCBC Table 4.1.5.3. Deck board applications live loads range from 1.9 to 4.8 kPa.

4.1.6 Loads Due to Snow and Rain

The maximum design snow and rain load is 100 psf (4.8 kPa) @ 16-inch (450 mm) o/c supports. Per BCBC 4.1.5.5.(3), design live load of exterior pedestrian areas is taken as the greater of the occupancy live load or snow and rain load, not combined.

4.1.7.1.(5) Wind Load

(a)

The maximum design wind uplift pressure for the deck boards is 125 psf (6.0 kPa). Specified wind pressure of secondary structural members is found by the static procedure equation in BCBC 4.1.7.3.

4.3.1.1 Design Basis for Wood

Trex Enhance® Basics and Naturals deck boards have been compared to those of materials in CSA 086, *Engineering Design in Wood*, and are found to perform as a suitable alternate for those materials when used for the intended purposes stated in the installation and limitations sections of this report. The alternative solution methodology is further discussed in Attachment 3.

4.3.1.3 Termites

Refers to article 9.3. See this report commentary to BCBC 9.3.2.9.



| <u>BCBC Div. B</u> <u>Section</u> | <u>Description</u> |
|--|--|
| 9.3.2.2 | Lumber Grades Trex Enhance® Basics and Naturals deck boards have been compared to those of materials in NLGA 2014, <i>Standard Grading Rules for Canadian Lumber</i> , and are found to perform as a suitable alternate for those materials when used for the intended purposes stated in the installation and limitations sections of this report. The alternative solution methodology is further discussed in Attachment 3. |
| 9.3.2.9.(5)(c) (i) | Termite and Decay Protection Trex Enhance® Basics and Naturals deck boards have been tested for decay and termite resistance and found to perform as well as pressure-treated Pine lumber in accordance with CAN/CSA-O80.1 for UC3.2 exterior construction. |
| 9.4.1.1.(1)(c) (i) | Structural Design Requirements and Application Limits The design methodology in this evaluation for determining conformance to Part 9 has been performed in accordance with BCBC 9.4.1.1.(1)(c)(i) using the loads and deflection limits specified in Part 9. |
| 9.4.2 | Specified Loads See this report commentary to BCBC 9.4.2.3. |
| 9.4.2.3 | Platforms Subject to Snow and Occupancy Loads See this report commentary to BCBC 4.1.3.2 for design load and deflection limits. The exterior balcony occupancy floor load in Part 9 is generally 1.9 kPa. Where exterior balconies are subject to snow loads, the greater of floor or snow load is to be used as the design load. |
| 9.4.3.1 | Deflections The deflection limits of BCBC Table 9.4.3.1 are met for applicable loading conditions. See this report commentary to BCBC 9.4.2.3. |
| 9.5.2.1.(1) | Barrier Free Design, General Refers to BCBC Section 3.8. See this report commentary to BCBC 3.8.3.2.(2)(c) and 3.8.3.3.(1)(a). |
| 9.8.9.1 | Loads on Stairs and Ramps The installation of Trex Enhance® Basics and Naturals deck boards at 16-inch (405-mm) span meets the strength and serviceability requirements for stairs at uniform loads of 1.9 kPa and 4.8 kPa. For improved serviceability, when installed as plank stair treads, it is recommended to use the design criteria of ASTM D7032, with supports spanned at maximum 9 inches (230 mm) to limit the deflection of a 300-lb (1.3 kN) point load at centre-span to ¼-inch (6.4 mm). |



9.8.9.6.(2) Finish for Treads and Landings

See this report commentary to BCBC 3.4.6.1.

9.10.3.2 Flame Spread Ratings

Refers to test methods in Part 3 and Appendix D. See this report commentary to BCBC 3.1.12.1.(2).

9.23.3.1.(3) Standards for Nails and Screws

Deck screws supplied by Trex for hidden fastening comply with ASME B18.6.1.

9.30.3.1.(1) Wood Strip Flooring, Thickness

The nominal thickness of Trex Enhance® Basics and Naturals deck boards meets BCBC Table 9.30.3.1 for exterior-use softwood lumber. The Trex materials are found to perform as well as a natural wood plank such as SPF No. 2 lumber for the intended purposes within the limitations of this report.

4.0 LIMITATIONS:

1. This Evaluation is for the base code requirements of the building system as addressed in this report. In some building applications, additional performance objectives may be required by Code which must be addressed in the building design for those specific cases.
2. Design calculations, drawings, and special inspections are to be furnished for building projects by registered professionals as required by the respective jurisdictional authorities and Codes.
3. Deck boards are to be installed with a minimum width-to-width gap of $\frac{3}{16}$ inch (4.8 mm), and end-to-end gap of $\frac{1}{8}$ inch (3.2 mm) if installed at greater than 4.5°C or $\frac{3}{16}$ inch (4.8 mm) if installed at less than 4.5°C, to allow for drainage and linear expansion of framing materials.
4. Deck boards are not for use as bracing against lateral (wind or seismic) loads.
5. Products are for exterior use only.
6. Products are to be used as exterior deck flooring planks only. No other functions of lumber materials used in buildings are addressed in this evaluation.
7. Strength and performance values apply to temperature at deck surface ranging from -29°C to 52°C.
8. Deck boards are to be fastened to wood framing built in conformance to BCBC Part 4 or Part 9 using corrosion resistant #7 screws supplied by Trex or jobsite supplied min. #8 wood deck screws complying with ASME B18.6.1.
9. The product is to be installed perpendicular to supports spaced no greater than 16 inch (405 mm) on center. Each plank is to span across at least three supports.
10. Installation directly to underfloor sheathing is not permitted. When installing over solid deck sheathing, sleepers of a minimum true dimension of 1.5 inch x 1.5 inch (38 mm x 38 mm) to be placed and fastened to framing, beneath as deck board supports, at maximum 16 inch (405 mm) on center perpendicular to deck boards.



5.0 FIRE CLASSIFICATION:

Summary of fire performance classifications found by testing to code referenced standards:

Combustible: Trex Enhance® Basics and Naturals deck boards are a *combustible* material as defined in BCBC, Div A, 1.4.1.2.

CAN/ULC S102.2: Flame Spread Index of 45.

6.0 QUALITY ASSURANCE ENTITY:

The products evaluated in this report are surveyed at the approved manufacturing locations with third-party quality assurance inspections and product certification labeling by QAI Laboratories, Inc.

7.0 MANUFACTURING PLANTS:

Manufacturing and labeling location(s): Winchester, VA; Fernley, NV.

8.0 LABELING:

Labeling shall be in accordance with the requirements of and bear the certification mark of the Accredited Quality Assurance Agency.

9.0 REFERENCE TESTING AND EVALUATION DOCUMENTS:

| Entity | Entity Accreditation ¹ | Standards | Report No. | Issue Date |
|---------------------------|-----------------------------------|-------------------------|-----------------|-------------|
| Intertek | IAS TL 144 | AWPA E10, ASTM D3345 | E5777.01-119-19 | 2015-Nov-04 |
| Intertek | IAS TL 144 | ASTM D7032, D7031, E330 | I5515.01-119-19 | 2018-Oct-25 |
| Intertek | IAS TL 144 | ASTM D695 | K1513.04-106-31 | 2019-Dec-09 |
| Right Testing Labs | IAS TL 859 | CAN/ULC S102.2 | RTL0017-3 | 2020-Mar-12 |
| Intertek | IAS TL 144 | ASTM F1679 | K8242.01-119-19 | 2020-Apr-23 |
| QAI Laboratories | SCC 10024 | Quality Assurance | B1109-1 | 2022-Mar-24 |

1. Testing, certification, evaluation, and inspection agencies referenced have been verified to be accredited by Standards Council of Canada (www.scc.ca) or International Accreditation Service (www.iasonline.org) for the applicable scope, in good standing on the date of the evaluation, in accordance with ISO 17025 and ISO 17020 international standards for testing and inspection bodies.

CERTIFICATION OF INDEPENDENCE:

1. Boca Engineering Co., it's employees and shareholders, do not have, nor do they intend to or will acquire, a financial interest in any company manufacturing or distributing products that they evaluate.
2. Boca Engineering Co. is not owned, operated or controlled by any company manufacturing or distributing products that they evaluate.



ATTACHMENT 1: MATERIAL PROPERTIES

| TABLE 1: TREX ENHANCE DECK BOARDS, MATERIALS PROPERTIES PER ASTM D7032 | | | | |
|---|--|--|--|---|
| D7032 Section | Property | Requirement | Value | |
| 4.4.1 | Flexural Strength Moment Capacity (M_u) | Report Value | 1563 in-lb (0.1767 kN-m) | |
| 4.4.2 | Flexural Stiffness (EI) | Report Value | 66,940 lb-in ² (0.1921 kN-m ²) | |
| 4.5.1 | Temperature Effect | Report % change of strength and stiffness @ 52°C & -29°C | Strength (52°C): | -33% |
| | | | Stiffness (52°C): | -44% |
| | | | Strength (-29°C): | 0% |
| | | | Stiffness (-29°C): | 0% |
| 4.5.2 | Moisture Effect | Report strength adjustments after water saturation | 0% water absorption, 0% adjustments | |
| 4.6 | Ultraviolet (UV) Effect | Report % increase/decrease of strength and stiffness after 2000 hrs of accelerated weathering | Strength: | -1% |
| | | | Stiffness: | -4% |
| 4.7 | Freeze-Thaw Effect | Report % change of strength and stiffness after three 24-hr freezing cycles @ -29°C | Strength: | 0% |
| | | | Stiffness: | -8% |
| 4.8.1 | Fungal Decay Resistance | Compare test block per AWPA E10 to ACQ pressure-treated lumber | Performed equivalent to ACQ-treated Pine | |
| 4.8.2 | Termite Decay Resistance | Compare test block per ASTM D3345 to ACQ pressure-treated lumber | Performed equivalent to ACQ-treated Pine | |
| 4.9 | Surface Burning Characteristics ¹ | Flame-spread index no greater than 200 | 45 | |
| 5.3.1 | Determination of Allowable Service Loads | Design strength and stiffness service values after climate adjustment factors, with strength safety factor of 2.5 applied | Moment Strength ($M_{SERVICE}$): | 419 lb-in (0.0474 kN-m) |
| | | | Stiffness ($EI_{SERVICE}$): | 37,486 lb-in ² (0.1076 kN-m ²) |
| 5.3.2 | Concentrated (Stair tread) Load | Deflection < 0.125" @ 300 lbf, and ultimate > 750 lbf | 9" span, $\Delta = 0.0641"$, Ult = 1181 lbf Meets requirements | |
| 5.4 | Creep-Recovery Test | 2x 100 psf design load for 24 hrs, min 75% deflection recovery | 85% Recovery Meets requirements | |
| 5.5 | Mechanical Fastener Holding Test | Report value of fastener pull-through of the deck board, and withdrawal from framing substrate, with strength safety factor of 3 applied | Pull-Through: | 180 lbf / screw |
| | | | Withdrawal: | 195 lbf / screw |
| 5.6 | Slip Resistance Test | Report the dry and wet coefficients of friction, tested by ASTM F1679 in the parallel and perpendicular-to-span directions | Parallel (Dry): | 0.51 |
| | | | Parallel (Wet): | 0.34 |
| | | | Perpendicular (Dry): | 0.53 |
| | | | Perpendicular (Wet): | 0.38 |
| Add. Tests | Wind Uplift | System maximum uplift design pressure, tested by ASTM E330-02, with safety factor of 3 applied | 125 psf (6.0 kPa) maximum uplift pressure at 16 inch (400 mm) maximum span | |
| | 90-day Load Duration | 2x 100 psf design load for 90-days, per ASTM D7031, no evidence of tertiary creep | No evidence of tertiary creep Meets requirements | |
| | Compressive Strength (psi) | Design compressive strength per ASTM D695 service values after climate adjustment factors, with strength safety factor of 2.5 applied | 370 psi (2.55 MPa) | |

1. CAN ULC/S102.2 test results substituted for ASTM E84 test.



#7 SCREW, T15 DRIVE,
1 5/8" LONG, 304SS

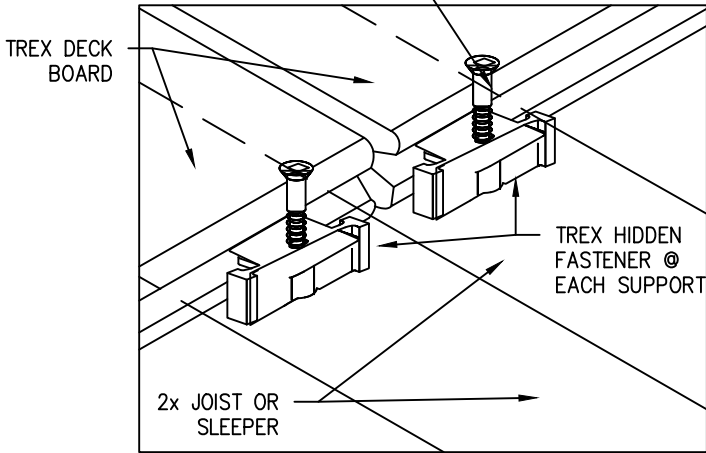

A
1 TYP. TREX HIDDEN FASTENER INSTALLATION
NOT-TO-SCALE

MIN. #8 OR #10 SCREW,
2 1/2" OR 2 3/4" LONG, 304SS

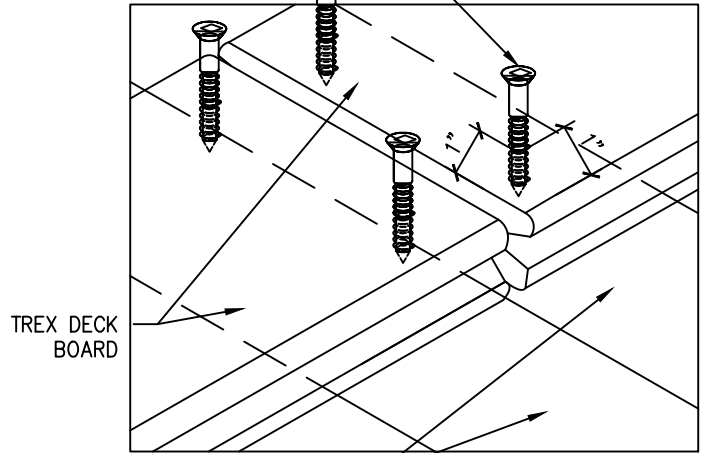

B
1 TYP. CONSTRUCTION FASTENER INSTALLATION
NOT-TO-SCALE

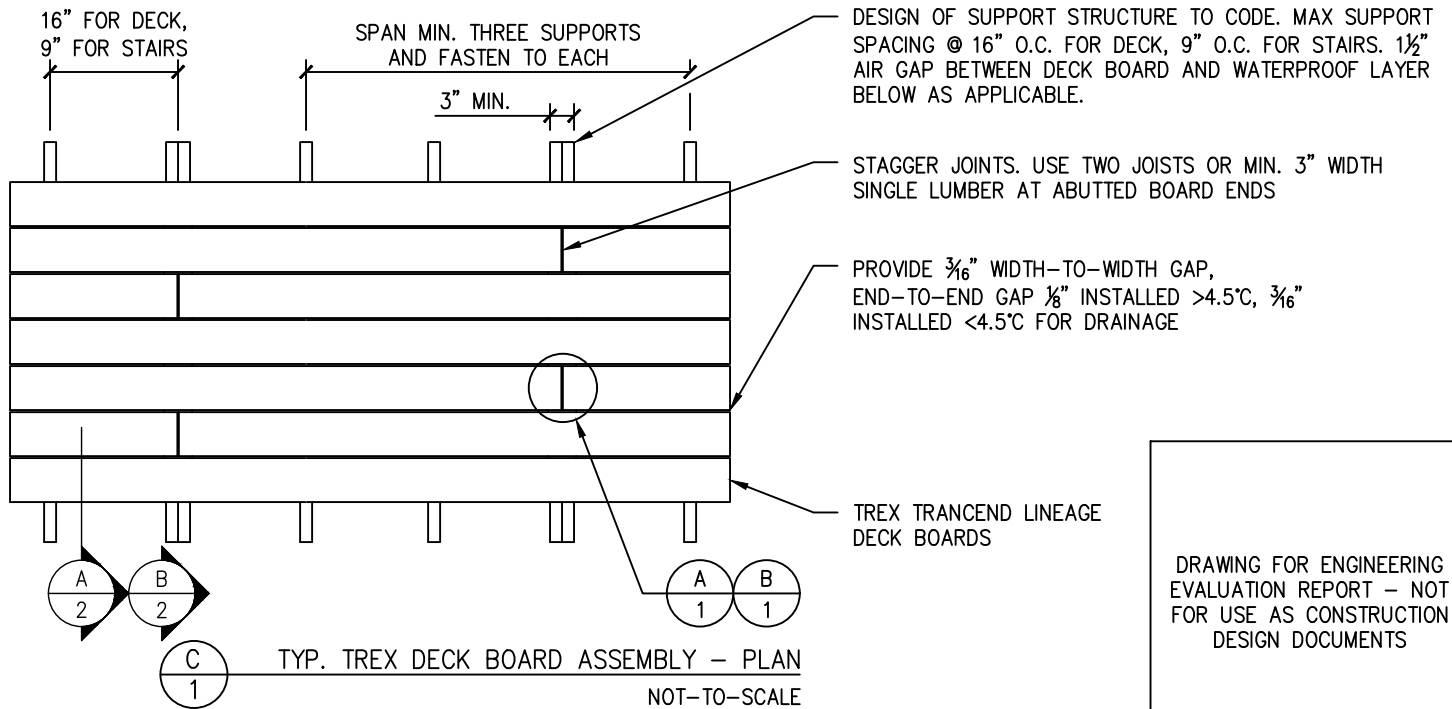

C
1 TYP. TREX DECK BOARD ASSEMBLY - PLAN
NOT-TO-SCALE

DRAWING FOR ENGINEERING
EVALUATION REPORT - NOT
FOR USE AS CONSTRUCTION
DESIGN DOCUMENTS

COPYRIGHT ©2022 RESERVED. THESE PLANS AND DESIGNS ARE AT ALL TIMES THE PROPERTY OF BOCA ENGINEERING CO. TO BE USED FOR THE PROJECT SHOWN. WRITTEN CONSENT IS REQUIRED FROM THE ENGINEER BEFORE ANY REPRODUCTION.

| | | |
|-------------------------------|---|--|
| CLIENT: TREX COMPANY, INC. | PROJECT: TREX ENHANCE DECK BOARDS | TITLE: TREX DECK BOARD TYP. ASSEMBLY & INSTALLATION DETAILS |
|-------------------------------|---|--|

| | | | |
|---------------------------|------------|------------------|--------|
| 0 | 2022/12/31 | FOR PUBLICATION | CB |
| REV | DATE | ISSUE | APP |
| DRAWING NO. 0084-SK1 | | DWG SHEET 1 OF 2 | DES CB |
| DATE DECEMBER 31, 2022 | | | DRN CL |
| | | | CHK CB |

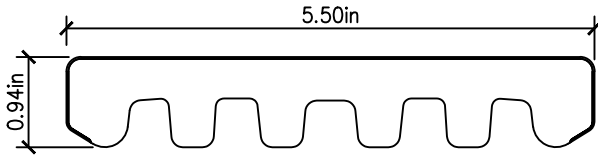

A
2 ENHANCE 1x6 SQUARE EDGE BOARDS
NOT-TO-SCALE

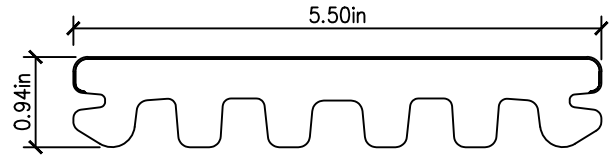

B
2 ENHANCE 1x6 GROOVED EDGE BOARDS
NOT-TO-SCALE

| DESIGN LOADS | |
|--------------|-----------------------|
| LIVE (DECK) | SEE EVALUATION REPORT |
| SNOW | |
| WIND | |
| SEISMIC | |
| TEMPERATURE | |

LEGEND AND SYMBOLS

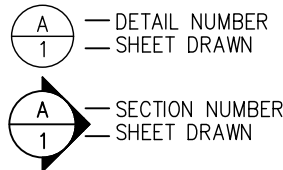

INSTALLATION

- FOR COMPLETE INSTALLATION DETAILS SEE TECHNICAL PRODUCT DATA ON PRODUCT MANUFACTURE'S WEBSITE.

MATERIAL STANDARDS

FASTENERS

- WOOD SCREWS: ASME B18.6.1-81(2016)
- NAILS: ASTM F1667-15
- METAL SCREWS: AISI S240-15, ASTM C1513-13
- ALL FASTENERS CORROSION-RESISTANT OR STAINLESS STEEL

FRAMING

- WOOD FRAMING: MIN. 2x4 S.G. 0.42, COMPLIANCE WITH CSA 0141-05
- METAL FRAMING: MIN. 18 GAUGE U.N.O., Fy = 33ksi, COMPLIANCE WITH CSA S136-12

INSPECTIONS (FIELD REVIEWS)

- NOTIFICATION FOR INSPECTIONS AND INSTALLATION APPROVAL SHOULD BE COMPLETED AS OUTLINED BY ANY OF THE FOLLOWING APPLICABLE TO THE REFERENCED PROJECT:
 - APPLICABLE LOCAL BUILDING CODE.
 - LOCAL BUILDING AUTHORITY.
 - PROJECT SPECIFICATION DOCUMENTS BY OTHERS.
- FIELD REVIEWS OF INSTALLATION ARE NOT COMPLETED BY THE EVALUATION REPORT ENGINEER.

ABBREVIATIONS

| | | | |
|------|------------|--------|------------------------|
| CONT | CONTINUOUS | O.C. | ON CENTER |
| EA | EACH | P.T. | PRESSURE TREATED |
| E/W | EACH WAY | S.G. | SPECIFIC GRAVITY |
| EXT. | EXTERIOR | SPEC. | SPECIFICATION |
| INT. | INTERIOR | NO. | TYPICAL |
| MAX | MAXIMUM | U.N.O. | UNLESS NOTED OTHERWISE |
| MIN | MINIMUM | W/ | WITH |
| NO. | NUMBER | | |

DESIGN

- STRUCTURAL WORK HAS BEEN DESIGNED IN ACCORDANCE WITH APPLICABLE CODES AND STANDARDS REFERENCED IN THE EVALUATION REPORT.
- THE STRUCTURAL FRAMING AND SHEATHING SHALL BE DESIGNED AND ANCHORED TO PROVIDE LATERAL BRACING AND PROPERLY TRANSFER ALL LOADS TO THE STRUCTURE. FRAMING DESIGN AND INSTALLATION IS THE RESPONSIBILITY OF THE ENGINEER OR ARCHITECT OF RECORD FOR THE PROJECT OF INSTALLATION.
- THESE DRAWINGS APPLY TO THE TESTED ASSEMBLY ONLY AND DO NOT IMPLY THAT THE SIGNATORY ENGINEER IS THE DESIGNER OF RECORD FOR ANY FUTURE CONSTRUCTION ON WHICH THEY ARE USED.

TESTING AND CODE COMPLIANCE

- THE PRODUCT ASSEMBLY SHOWN HAS BEEN EVALUATED ACCORDING TO THE TEST STANDARDS AS OUTLINED IN THE EVALUATION REPORT.
- THE INSTALLATION DETAILS DESCRIBED ARE OF THE LABORATORY TESTED ASSEMBLY AND MAY NOT REFLECT ACTUAL CONDITIONS FOR A SPECIFIC SITE. IF SITE CONDITIONS DEVIATE FROM THE REQUIREMENTS DETAILED HEREIN, THE LICENSED ENGINEER OR ARCHITECT PREPARED SITE-SPECIFIC DOCUMENTS SHALL BE USED.

COPYRIGHT ©2022 RESERVED. THESE PLANS AND DESIGNS ARE AT ALL TIMES THE PROPERTY OF BOCA ENGINEERING CO. TO BE USED FOR THE PROJECT SHOWN. WRITTEN CONSENT IS REQUIRED FROM THE ENGINEER BEFORE ANY REPRODUCTION.

DRAWING FOR ENGINEERING EVALUATION REPORT – NOT FOR USE AS CONSTRUCTION DESIGN DOCUMENTS

| | | | |
|---------------------------|------------|------------------|-----------|
| 0 | 2022/12/31 | FOR PUBLICATION | CB |
| REV | DATE | ISSUE | APP |
| DRAWING NO. 0084-SK1 | | DWG SHEET 2 OF 2 | |
| DATE DECEMBER 31, 2022 | | DES CB | DRN CL |
| | | CHK CB | |

| | | |
|-------------------------------|--------------------------------------|--|
| CLIENT: TREX COMPANY, INC. | PROJECT: TREX ENHANCE DECK BOARDS | TITLE: TREX DECK BOARD PROFILES & GENERAL NOTES |
|-------------------------------|--------------------------------------|--|



ATTACHMENT 3: DISCUSSION OF LIMIT STATES DESIGN PROCEDURE

Acceptable Solutions

Once the materials properties of the Trex deck boards have been established, design to prescribed performance requirements in the code can be conducted. From the perspective of meeting the requisite acceptable solutions of the in-use performance required by Code for exterior deck planks, much of this design evaluation fits within the acceptable solution methodology of Part 3/Part 4 and of Part 9, where the specific Code requirements are shown to meet the Code as-written.

Alternative Solutions - Wood-Plastic Composite (WPC) Components

The wood-plastic composite (WPC) components do not fit within a code-referenced material standard, so an alternative solution design evaluation method is employed to ensure that the material as installed meets the minimum level of performance required by Code following BCBC Div A 1.2.1.1.(1)(b).

The deck board material dimensions, constituents, installation methods, and end-use as an exterior deck plank, most closely align as an alternate for natural wood materials used for the same purpose that fall within acceptable solution materials specifications in Div B, Articles 4.3.1.1, 4.3.1.3, 9.3.2.2, 9.3.2.9.(5)(c)(i), and 9.30.3.1.(1). Article 4.3.1.1 furthers refers to CSA 086, *Engineering Design in Wood*, and Article 9.3.2.2 further refers to NLGA 2014 *Standard Grading Rules for Canadian Lumber*.

Appropriate published standards by organizations accredited by Standards Council of Canada have been used to complete the alternative solutions evaluation through testing and design modeling.

ASTM D7032-17, *Standard Specification for Establishing Performance Ratings for Wood-Plastic Composite and Plastic Lumber Deck Boards, Stair Treads, Guards, and Handrails*, has methods for testing the strength and deflection of deck boards inclusive of considering the effects of possible strength loss due to temperature, aging, moisture, and freeze-thaw. The deck board properties found through testing were taken through a design model using the loading requirements of BCBC Part 4 and Part 9.

Design of structural components by strength testing with a test load (safety) factor in limit states design necessitates the computation of a test load factor for the respective stress and failure type due to the various loading types. Deck plank members are typically stressed to failure in bending or in shear, depending on the placement of the test load with respect to the connection/support of the member.

Test Load Factors are computed by:

$$\text{Test Load Factor} = \frac{\text{Combined Load Factor}}{\text{Resistance Factor}}$$

ASTM D7032 recommends a safety factor (test factor) of 2.5 applied to service-level loads. In limit states design standards, a material resistance factor is typically published, which allows for computation of a test factor. When no resistance factor is available and the standard stipulates a test factor, the computation becomes of finding the effective resistance factor. In this evaluation, the effective resistance factor for all loading/stress types is $\Phi = 0.60$.



The applicable objectives and functional statements from BCBC Div A Part 2 and 3, taken from the referenced Div B acceptable solutions, that the WPC components have been verified to satisfy are:

Objectives are to limit the risk of injury, illness, or damages, caused by:

Symbol Description

| | |
|-------|---|
| OS2.1 | Ultimate loads on building elements |
| OS2.3 | Damage or deterioration of building elements |
| OH4 | Illness attributed to vibration and deflection |
| OP2.1 | Loads bearing on the building elements that exceed their loadbearing capacity |
| OP2.3 | Damage to or deterioration of building elements |
| OP2.4 | Vibration or deflection of building elements |

The building elements are to perform the following functions:

Symbol Description

| | |
|-----|--|
| F20 | Support and withstand expected loads |
| F21 | Limit dimensional change |
| F22 | Limit movements under expected loads and forces |
| F80 | Resist deterioration from expected service conditions |
| F81 | Minimize the risk of malfunction, interference, damage, tampering, lack of use or misuse |